

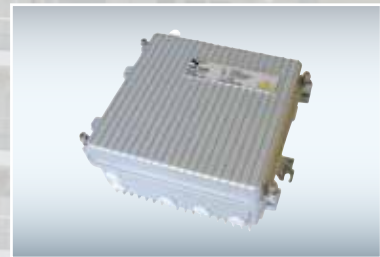

# Fibre Optics for cable TV

| Triax fibre optic solutions take your  
CATV network to the next level



your ultimate connection

# Triax Fibre Network Equipment

## | Structure of Fibre Optic Networks for Cable TV Systems



### The fibre possibilities

Cable Television Networks have a centralized Headend where the signals are processed and then distributed via a fibre optic infrastructure to sub headends.

The centralized CATV headend processes the signals from Terrestrial or Satellite sources converts them to RF and then to an optical output which is then sent out to the network. Internet and return path signals can be added to the fibre network at the main headend.

All of the fibre optic cables are distributed and terminated at the optical receiver or node within the cabinet; this is referred to as fibre to the curb FTTC. The Optical nodes convert the signal from light back to RF so that they can be distributed to the home via coaxial cabling.

The following network structures are now commonplace:

#### ■ **HFC**

Hybrid Fibre Coax (HFC) networks are ideal for transmitting RF signals with a large bandwidth. It is a combination of fibre optic distribution and coaxial cable for final delivery to the home. The signals travel over large distances through the fibre and are converted to coax for the last 100m. This a cost effective method of delivery as the subscribers only require a termination point within the home.

#### ■ **FTTX**

FTTX is a collective acronym used within the industry to encompass all distribution methods such as Fibre to the curb (FTTC), fibre to the building (FTTB) and fibre to the home (FTTH).

#### ■ **FTTC**

Fibre to the curb (FTTC) is defined as the laying of fibre optic cables to a distribution cabinet at the curb.

## | A choice of active components for your

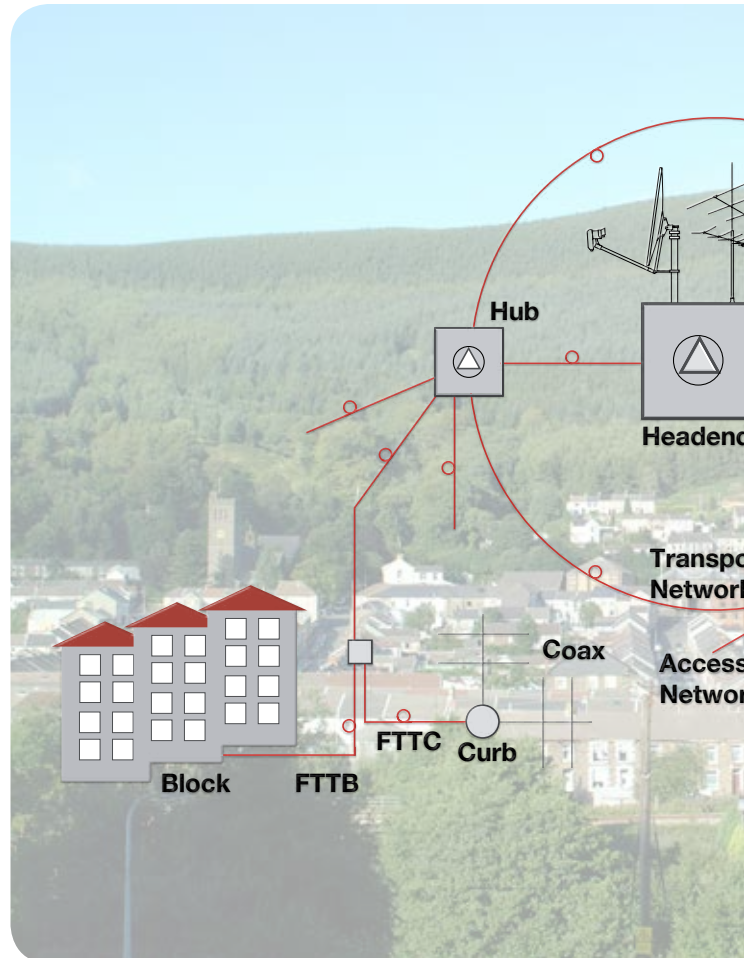

#### ■ **FTTB**

Fibre to the building (FTTB) is defined as the laying of fibre optic cables to the building. As an example, the fibre optic cables are laid within the existing ducting to the basement of the apartment block. The Fibre is terminated by an optical node and converted to RF where it is then distributed internally via coaxial cable to each apartment.

#### ■ **FTTH**

Fibre to the home (FTTH) is defined as the laying of optical transmitter directly to the home.

## CATV fibre access network

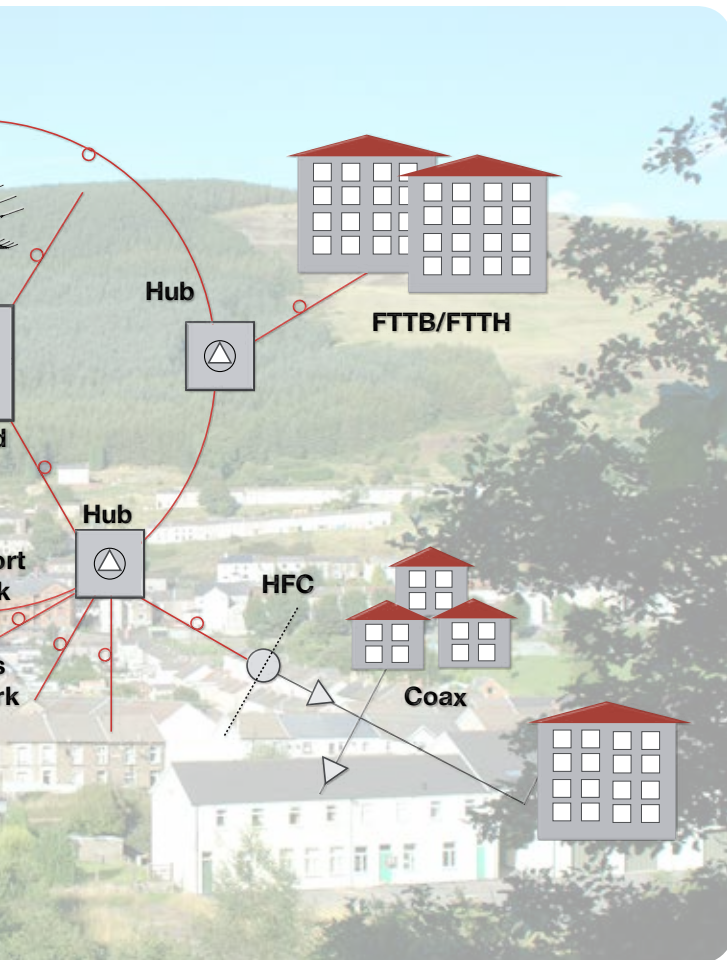

Each home has a domestic fibre to coax converter, receiver or node. This example gives the resident all services such as TV, VOD and internet (triple play)

### ■ **RFoG**

Radio Frequency over Glass (RFoG) is sometimes referred to as RF over fibre. This is a method of designing the optic fibre network infrastructure where it utilises passive optical splitters to maximize the reach of the network in a cost effective way. This ensures signals are distributed to the largest number of subscribers.

<b>CATV - HFC components</b>	<b>Page</b>
■ Optical transmitters 1310 nm	4
■ Overview optical receivers/fibre nodes	5
■ Optical receiver - FTTH	6
■ Optical receiver - FTTB	7
■ Optical receiver - FTTB, HFC	8 - 9
■ Fibre nodes with return path transmitter	10 - 11
■ Segmentable Fibre Node HFC/FTTC	12-13
■ Fibre Nodes Plug-in modules	14-15





# Fibre Optics

## | Optical transmitter 1310 nm for HFC networks

- Directly modulated and cooled high-performance DFB laser
- Automatic processor-controlled adjustment of the laser drive with regard to level and channel loading of various RF input signals produces the best transmission characteristics in terms of low intermodulation (CTB/CSO) and low noise
- Multichannel pre-distortion and GaAs amplifier technology also provide the best signal quality with low noise and low distortion
- 32-bit microprocessor for automatic monitoring and control of the laser ensures constant output level and long service life
- 19" 1 HE enclosure with 10TBase Ethernet (IEEE802.2) and RS 232 interface for external network monitoring
- Other output levels available on request
- RF connectors: F female
- Fibre optic connectors: SC/APC



### Technical specification

Type		OTXS 06-1	OTXS 20-1
Art. No.		307507	307521
Optical output power	mW	6.0	20.0
Optical output power	dBm	8.0	13.0
<b>RF input</b>			
Frequency range	MHz	47 - 862	47 - 862
Level (84 PAL D channels)	dBμV	85 ±3	85 ±3
Test point (F-connector, front)	dB	-20	-20
Flatness in band	dB	±0.75	±0.75
Return loss	dB	>18	>18
<b>Optical System</b>			
Wavelength	nm	1310	1310
CTB (Non linear distortion) (Popt in = - 1 dBm, 84 PAL D channels)	dB	>65	>65
CSO (Non linear distortion) (Popt in = - 1 dBm, 84 PAL D channels)	dB	>60	>60
C/N (Popt in = - 1 dBm, B=5MHz)	dB	>51	>51
Test point - RF input(F-connector, front)	dB	-20	-20
Laser type		DFB, temperature controlled	
<b>Additional</b>			
Monitoring interfaces		RS232 for software, RJ45 for LAN Ethernet	
Monitoring display	dot	160 x 32	
Input connectors (for RF)		F-Connector	
Fibre connectors (for fibre optic cable)		SC/APC	
Housing		19", 1 HE	
Power supply	VAC	110 - 253 (50 MHz)	
Dimensions (w x h x d)	mm	480 x 44 x 380	

# Fibre Optics

## | Overview Optical Receivers and Fibre Nodes

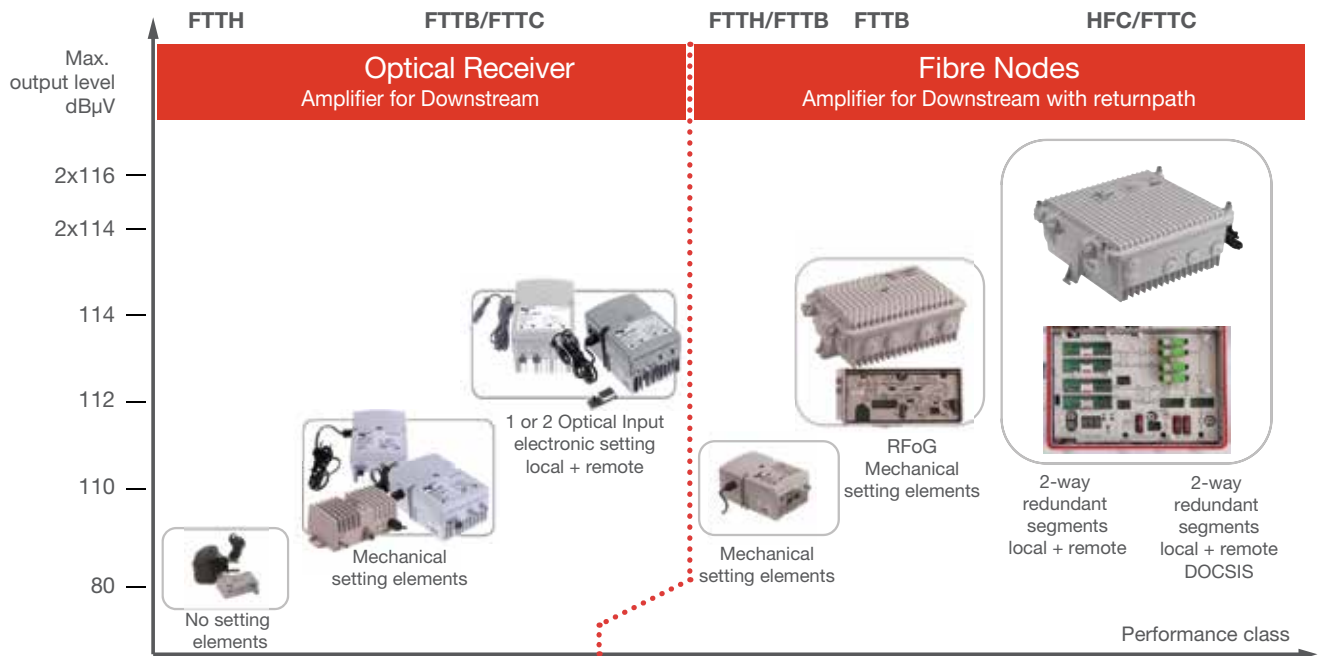

Variant Receiver/Fibre Node								
Delivery	*	**	*	**	*	**	**	***
1 Optical input, local feed	ORH 100	ORB 923	ORB 929	ORB 729/1	ORB 1923	ORC 1629 M	ORC 2729 TRX	ORC 2731 TRX
1 Optical input, remote feed						ORC 1629 L		
2 Optical inputs, local feed				ORB 729/2			ORC 2729 M	ORC 2731 M
2 Optical inputs, remote feed							ORC 2729 L	ORC 2731 L
Special features/use in	FTTH	FTTB/HFC	FTTB/HFC	FTTB/HFC	Allround fibre node	RfOG - Burst Mode	HFC/FTTC segmentable	HFC/DOCSIS segmentable
Module								
Control + Monitoring locally via HotSwap remote via SNMP				TCM 729 TMM 729			TMM 2729	TDM 2731 DOCSIS
Receiver forward	-	-	-	-	-	TRX 2729	TRX 2729	TRX 2729
Sender returnway	-	-	-	-	OTBM...	OTBM...	TTX...	TTX...
Output modules	-	-	-	-	-	TSTI... TTSI... TJMP 01	TSTI... TTSI... TJMP 01	TSTI... TTSI... TJMP 01
Diplexer	-	-	-	-	-	DPF 2729/65	DPF 2729/65	DPF 2729/65
Return HP-filter	-	-	-	-	-	-	FPA 2729...	FPA 2729...

\* From stock  
 \*\* Order for projects  
 \*\*\* On request - Special requirements for configurations and delivery have to be figured out

# Fibre Optics

## | Optical receiver FTTH for individual households

The ORH 100 optical receiver is a highly cost effective optical network termination for an individual residence. The receiver's output is directly connected to outlets via passive coaxial distribution.

Simple setting up and stable operation via AGC and LED display.

Receiver is supplied in a plastic hood with a plug-in power supply.

- AGC for constant RF output level
- 3-colour LED for rapid indication of the correct optical input level
- Compact and space saving
- Low power consumption
- Includes 9V power supply
- SC/APC connection at optical input
- RF output level 80 dB $\mu$ V



### Technical specification

Type	ORH 100		
Art. No.	307565		
<b>Optical Characteristics</b>			
Input level ( $P_{in}$ )		dBm	- 10...+1
AGC range		dBm	- 6...0
Optical Return Loss		dB	>40
Wavelength		nm	1100...1650
Equivalent input noise		pH/(Hz)	6.5
Optical power indicator LED	orange green red	dB	$P_{in} < -6$ $-6 < P_{in} < 0$ $P_{in} > 0$
Optical connector			SC/APC
<b>RF parameters</b>			
Frequency range		MHz	47...862
Gain flatness		dB	$\pm 1.0$
Max. Output level (42 Ch. CENELEC)	CTB<60 dBc CSO<60 dBc	dB $\mu$ V dB $\mu$ V	80 80
Level output stability in the AGC mode		dB	$\pm 1$
Return Loss		dB	>18 (40 MHz) -1,5/Octave
RF output connector			F-female
<b>Operating voltage and Additional data</b>			
Operating voltage		VAC/Hz	ext. Power Supply 9 V / 150 mA
Input		W	< 1
Protection class			IP 40
Operating temperature range		$^{\circ}$ C	-20...+55
Weight		kg	0,1
Dimensions (w x h x d) incl. plastic cover		mm	60 x 50 x 20

# Fibre Optics

## | Optical Receiver FTTB for multi-dwelling homes

The ORB 923 is an optical receiver in a compact die-cast housing. The relatively high output level enables very cost effective FTTB installations in medium sized residential buildings.

Optical level signalling and automatic gain control provide the correct as well as constant RF output level within a wide optical input level window. Settings are made using reliable plug-in pads.

- AGC for constant RF output level
- 3-colour LED for rapid indication of the correct optical input level
- Level control and equalizer adjusted via JXP plug-in pads \*)
- High output level 110 dB $\mu$ V
- with low power consumption

\*) Model ORB 823 with potentiometer available on request

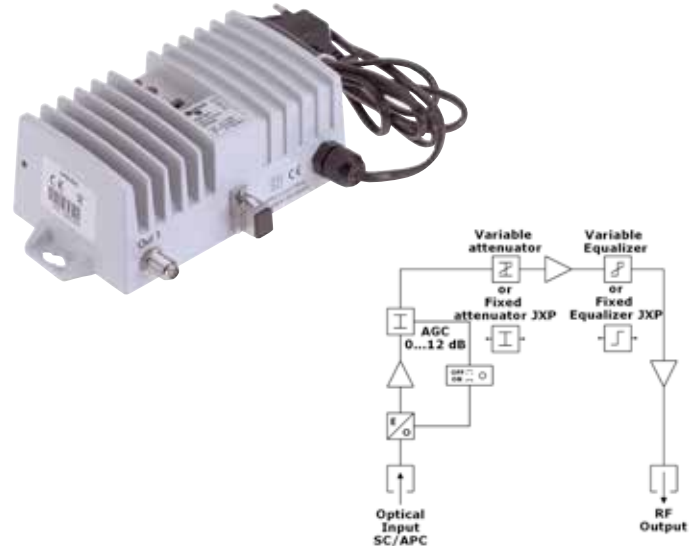

### Technical specification

Type		ORB 923	
Art. No.		307563	
<b>Optical Characteristics</b>			
Input level (P <sub>in</sub> )		dBm	- 8...+1
AGC range		dBm	- 6...0
Optical Return Loss		dB	>40
Wavelength		nm	1100...1650
Equivalent input noise		pH/(Hz)	8.0
Optical power indicator LED	orange green red	dB	P <sub>in</sub> < -6 -6 < P <sub>in</sub> < 0 P <sub>in</sub> > 0
Optical connector			SC/APC
<b>RF parameters</b>			
Frequency range		MHz	47...862
Gain flatness		dB	± 0.75
Max. Output level (DIN 45004 B)		dB $\mu$ V	123
Max. Output level (42 Kan. GENELEC)	CTB<60 dBc	dB $\mu$ V	110
9 dB slope 3,5 %	CSO<60 dBc	dB $\mu$ V	110
Level output stability in the AGC mode		dB	± 1
Attenuator		dB	JXP plug-in 0...20
Equalizer		dB	JXP plug-in 0...20
Return Loss		dB	>18 (40 MHz) -1,5/Octave
RF output connector			F-female
<b>Operating voltage and Additional data</b>			
Operating voltage		VAC/Hz	180...253/50-60
Input		W	< 5.5
Protection class			IP 40
Operating temperature range		°C	-20...+55
Weight		kg	0,76
Dimensions (w x h x d)		mm	155 x 56 x 96

# Fibre Optics

## Optical Receiver FTTB for larger buildings and HFC networks

The ORB 929 is a very compact high-performance optical receiver for cable TV systems without a return path.

Its high degree of control enables it to be used as an optical network unit in both FTTC and FTTB constellations as well as in HFC networks with subsequent coaxial amplifiers on the line.

Easy indication of optical input level via LED display. Reliable long-term operation by use of JXP pads to make adjustments as well as regulation of optical level fluctuation via AGC.

- LED display (2-digit, 7-segment) for accurate indication of optical input level
- Level control and equalizer adjusted via JXP attenuator pad\*)
- Level control 0...20 dB
- Equalizer 0...20 dB
- External test point for output level
- High output level 114 dBμV

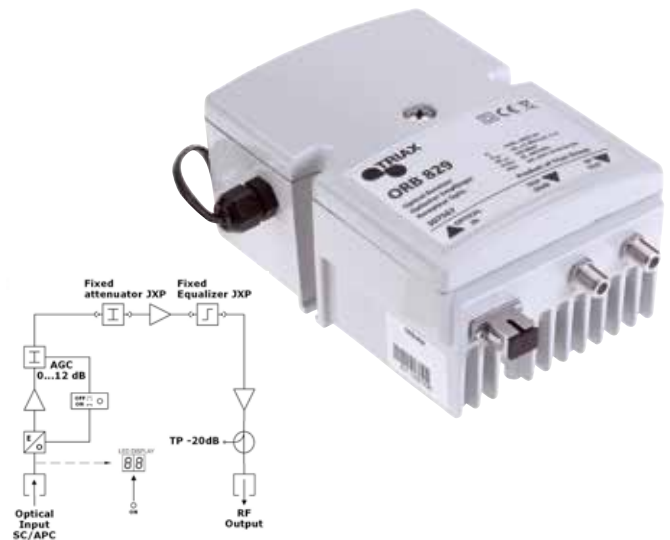

### Technical specification

Type	ORB 929		
Art. No.	307568		
<b>Optical Characteristics</b>			
Input level (P <sub>m</sub> )	dBm	- 10...+1	
AGC range	dBm	- 6...0	
Optical Return Loss	dB	>40	
Wavelength	nm	1100...1650	
Max. Optical Input level	dBm	+ 3.0	
Optical level range (2 digit, 7 segments)	dBm	- 9.9...+2	
Optical connector		SC/APC	
<b>RF parameters</b>			
Frequency range	MHz	47...862	
Gain flatness	dB	± 0.75	
Max. Output level (DIN 45004 B)	dBμV	129	
Max. Output level (42 Kan. CENELEC)	CTB<60 dBc	dBμV	114
9 dB slope 3,5 %	CSO<60 dBc	dBμV	114
Level output stability in the AGC mode	dB	± 1	
Attenuator	dB	JXP plug-in 0...20	
Equalizer	dB	JXP plug-in 0...20	
Return Loss	dB	>18 (40 MHz) -1,5/Octave	
Test point	dB	- 20	
RF output connector		F-female	
<b>Operating voltage and Additional data</b>			
Operating voltage	VAC/Hz	180...253/50-60	
Input	W	< 13.0	
Protection class		IP 64	
Operating temperature range	°C	-20...+55	
Weight	kg	1.1	
Dimensions (w x h x d)	mm	107 x 155 x 75	



# Fibre Optics

| Micro controlled optical receiver for FTTB/HFC networks with option of optical path redundancy

Optical receivers of the ORB 7-series are very compact high-performance optical network units for FTTB-/FTTC and HFC cable TV systems without a return path.

Uninterruptible, electronic settings and monitoring of device parameters either on the device or via Ethernet interface

Professional operating and monitoring features:

- Locally on the device with hot-swap module TCM 729 via a keyboard
- Remote monitoring with monitoring module TMM 729 (RJ45 Ethernet interface via SNMP protocol)
- Independent switching of optical inputs with alarm function (ORB 729-2)
- Electronic level control and equalizer
- Second RF output, configurable via plug-in module
- Monitoring parameters: optical input- path and level, input signal switching hysteresis, output level, temperature, attenuation, equalizer and more
- Output level 114 dB $\mu$ V

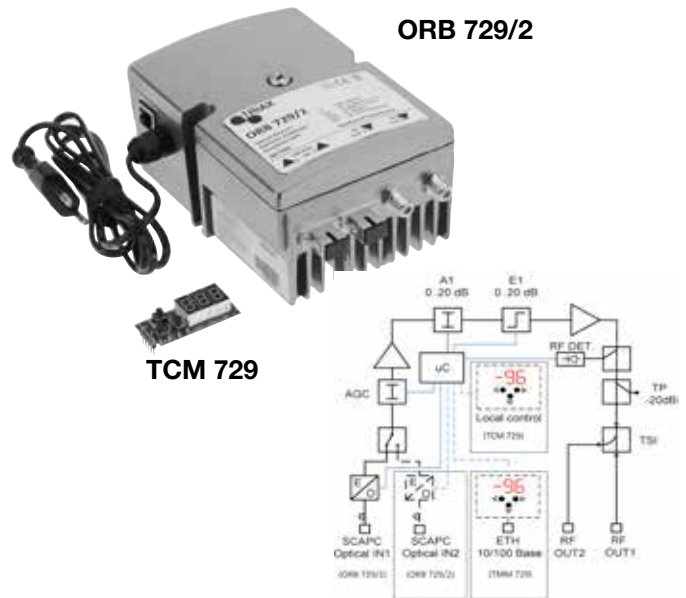

## Technical specification

Type	ORB 729-1	ORB 729-2	TCM 729	TMM 729
Art. No.	307700	307703	307708	307709
Optical input	1	2		
Local control via keyboard hot swap			X	X
Remote monitoring via Ethernet (SNMP)				X
<b>Optical Characteristics</b>				
Input level range (P <sub>IN</sub> )				
	dBm			
AGC range				
	dBm			
Optical return loss				
	dB			
Optical input wavelength				
	nm			
Max. optical input level				
	dBm			
Equivalent input noise current				
	pA/(Hz) <sup>1/2</sup>			
Optical power indicator range accuracy:	electronic 3 x LED			
	dBm			
Optical connector(s)				
<b>RF parameters</b>				
Frequency range				
	MHz			
Gain flatness				
	dB			
Max. Output level (DIN 45004 B)	CTB<60 dBc			
	dB $\mu$ V			
1310nm@-3dBm, 9 dB slope, 3.5% OMI, AGC off CSO<60 dBc				
	dB $\mu$ V			
Level output stability in the AGC mode				
	dB			
Interstage attenuator				
	dB			
Interstage equalizer				
	dB			
Return loss				
	dB			
Output test point				
	dB			
RF output connector				
<b>Operating voltage and Additional data</b>				
Operating voltage	VAC/Hz			
Input	W			
Protection class				
Operating temperature range	°C			
Weight	kg			
Dimensions (w x h x d)	mm			

# Fibre Optics

## Allround Fibre Node FTTB for multiple dwellings and HFC networks

The ORB 1923 is a very compact high-performance optical network unit for two fibre way networks with a return path.

Its high degree of control and free selection of the return path laser modules enables it to be used as an optical network unit in both FTTC and FTTB constellations as well as in HFC networks with subsequent coaxial amplifiers down the line.

Reliable long-term operation by using JXP pads to make settings as well as regulation of optical level fluctuations via AGC.

- 3-colour LED to indicate the optical input signal level
- Level control and equalizer adjusted via JXP attenuator pad
- External test point for output level
- Large selection of laser modules (order separately)
- High output level 109 dBμV

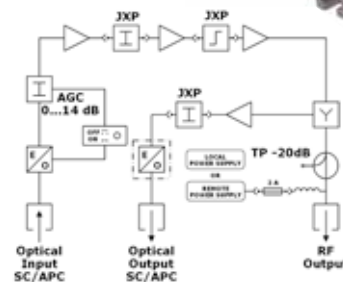

### Technical specification

Type		ORB 1923	
Art. No.		307717	
<b>Optical Characteristics</b>			
Input level (P <sub>n</sub> )	dBm	-9...+1	
AGC range	dBm	-6...0	
Optical Return Loss	dB	>40	
Wavelength	nm	1100...1650	
Max. Optical Input level	dBm	+3.0	
Equivalent input noise current	pA/Hz	< 8	
Optical power indicator LED	orange/green/red	P <sub>n</sub> < -7 / -7 < P <sub>n</sub> < 0 / P <sub>n</sub> > 0	
Optical connector		SC/APC	
<b>RF parameters, forward path</b>			
Frequency range	MHz	87...862	
Gain flatness	dB	+0.75	
Max. Output level (DIN 45004 B)	dBμV	123	
Max. Output level (42 Kan. CENELEC)	dBμV	CTB<60 dBc	109
Max. Output level 9 dB slope 3,5 % OMI	dBμV	CSO<60 dBc	109
Level output stability in the AGC mode	dB	+1	
Attenuator	dB	JXP plug-in 0...20	
Equalizer	dB	JXP plug-in 0...20	
Return Loss	dB	>18 (40 MHz) -1,5/Octave	
Test point	dB	-20	
RF output connector		F-female	
<b>RF parameters, return path</b>			
Frequency range		5...65	
Return gain		20	
Gain flatness		±1	
Level adjustment		JXP plug-in 0...20	
<b>Return path module, transmitter types</b>			
Optical wavelength		1310	1310 1550/CWDM
Output optical power		0/1	3/2 3/2
Laser type		FP	DFB DFB
Optical connector		SC/APC	
<b>Operating voltage and Additional data</b>			
Operating voltage	VAC/Hz	180...253/50-60	
Input	W	< 9	
Protection class		IP 64	
Operating temperature range	°C	-20...+55	
Weight	kg	1.1	
Dimensions (w x h x d)	mm	107 x 155 x 75	

# Fibre Optics

## | High performance RFoG Fibre Node FTTB

The ORC 1629 M and ORC 1629 L are compact fibre nodes with an optical receiver in the forward path and an optical transmitter in the return path. The high output level enables direct connection to passive coaxial house distribution networks without further amplification.

The burst mode control only switches on the return path laser transmitter if the CMTS controlled cable modem transmits downstream. This avoids the noise overlapping of passively interconnected RW transmitters in an RFoG network.

- AGC for constant RF output level
- Diverse plug-in return path transmitter modules OTBM selectable
- Uninterruptible setting of level control and equalizer with automatic 5 dB fall-back value via JXP attenuation pad
- Four selectable trigger levels for burst mode
- Second output with configurable by plug-in modules
- High output level 114 dBμV

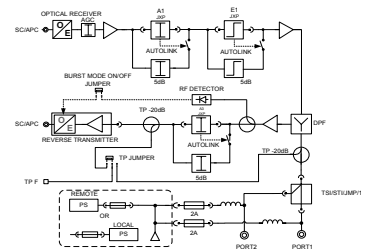

### Technical specification

Type		ORC 1629 M	ORC 1629 L
Art. No.		307562	307563
<b>Optical Characteristics</b>			
Input level ( $P_{in}$ )		dBm	-9...+2
AGC range		dBm	-6...0
Optical Return Loss		dB	>40
Wavelength		nm	1100...1650
Max. Optical Input level		dBm	
Equivalent input noise current		pA/Hz	< 5
Optical power indicator LED	orange/green/red	dB	$P_{in} < -7 / -7 < P_{in} < 0 / P_{in} > 0$
Optical connector			SC/APC
<b>RF parameters, forward path</b>			
Frequency range		MHz	87...1006
Gain flatness		dB	+ 0.75
Max. Output level (42 Kan. CENELEC)	CTB<60 dBc	dBμV	114
Max. Ausgangspegel 9 dB slope, 4 % OMI	CSO<60 dBc	dBμV	114
Level output stability in the AGC mode		dB	+ 1
Interstage attenuator A1	1 dB PADS	dB	0...15
Interstage attenuator E1	1 dB PADS	dB	0...15
Return Loss		dB	>18 (40 MHz) -1,5/Octave
Test point		dB	- 20
RF output connector			PG 11/5/8"
<b>RF parameters, return path</b>			
Frequency range		MHZ	5...65
Return Gain		dB	30 ± 0.75
Gain flatness		dB	+ 0.75
Attenuators A3		dB	0...20
Return loss			20 ± 1
Trigger level for Burst Mode			4 selectable levels: 70-72, 75, 80, 82
Test points - return path			20
Return transmitters (via OTBM xxxx plug-in modules, order separately)			1310FP: 0dBm, 1310/1550/CWDM DFB: +3dBm
<b>Operating voltage and Additional data</b>			
Operating voltage	VAC/Hz		180...253/50-60
Input	W		< 17
Protection class			IP 64
Operating temperature range	°C		-20...+60
Weight	kg		1,3
Dimensions (w x h x d)	mm		235 x 145 x 80

# Fibre Optics

## Segmentable Fibre Node for CATV distribution networks

The ORC 2729 Fibre Node platform provides extensive configuration and control options for use as the termination of a fibre optic distribution network in HFC or FTTC/FTTB structures.

Full redundancy and electronic monitoring of all parameters on the device enable amongst others the uninterruptible switching of fibre optic feeder paths in the forward and return direction.

- Configurable, for example as 2x2(3) HFC node or 1x2(3) FTTC node
- Settings are made electronically via a keypad and a 3-digit LED display or optionally via the TMM2729 (RJ 45) Ethernet monitoring module and a browser.
- Signal parameters, device setting and alarms are monitored and controlled remotely via SNMP.
- Device variant ORC 2931 with optional DOCSIS monitoring module TDM 2931 available on request
- Full product range of return path transmitter modules TTX



ORC 2729

TMM 2729

\*) Without optical receiver and transmitter modules

### Technical specification

Type		ORC 2729 M	ORC 2729 L	TRX 2729	TMM 2729
Art. No.		307840	307843	307850	307845
Optical input		Mains powered *)	Line powered *)	Opt. Rec. module	Monitoring Module
Slots for optical forward receiver		1	2	Forward	
Local control via keyboard hot swap		X	X		X
Remote monitoring via Ethernet RJ 45					X
<b>Optical Characteristics</b>					
Input level (P <sub>in</sub> )	dBm	-9...+2			
AGC range	dBm	-6...0			
Optical Return Loss	dB	>45			
Wavelength	nm	1100...1650			
Max. Optical Input level	dBm				
Equivalent input noise current	pA/Hz	< 5			
Optical connector		SC/APC			
<b>RF parameters, forward path</b>					
Frequency range	MHz	87...1006			
Gain flatness	dB	± 0.75			
Max. Output level (42 Kan. CENELEC)	CTB<60 dBc	dBµV 114			
Max. Output level 9 dB slope 3.5 % OMI	CSO<60 dBc	dBµV 114			
Level output stability in the AGC mode	dB	± 1			
Attenuator	dB	0...18 / 0.5 dB step			
Equalizer	dB	0...18 / 0.5 dB step			
Return Loss	dB	>18 (40 MHz) -1.5/Octave			
Test point	dB	- 20 +1			
<b>RF parameters, return path</b>					
Frequency range		5...65			
Return gain		30 ±0.75			
Gain flatness		±0.75			
Level adjustment A3, A4		Adjustable 0...20			
Return Loss		20			
Slots for return path transmitter modules		2			
Return path laser (see TTX modules)		1310 FP: 0 dBm // 1310/1550/CWDM DFB: 3/6 dBm			
<b>Operating voltage and Additional data</b>					
Operating voltage	VAC/Hz	180...253/50-60	24...90/50-60		
Input	W	< 31			
Optical connector		PG 11/5/8"			
Protection class		IP 67			
Operating temperature range	°C	-20...+55			
Weight	kg	3.65			
Dimensions (w x h x d)	mm	256 x 212 x 125			



# Fibre Optics

| Segmentable Fibre Node  
for CATV distribution networks

## | ORC 2729 - diagram

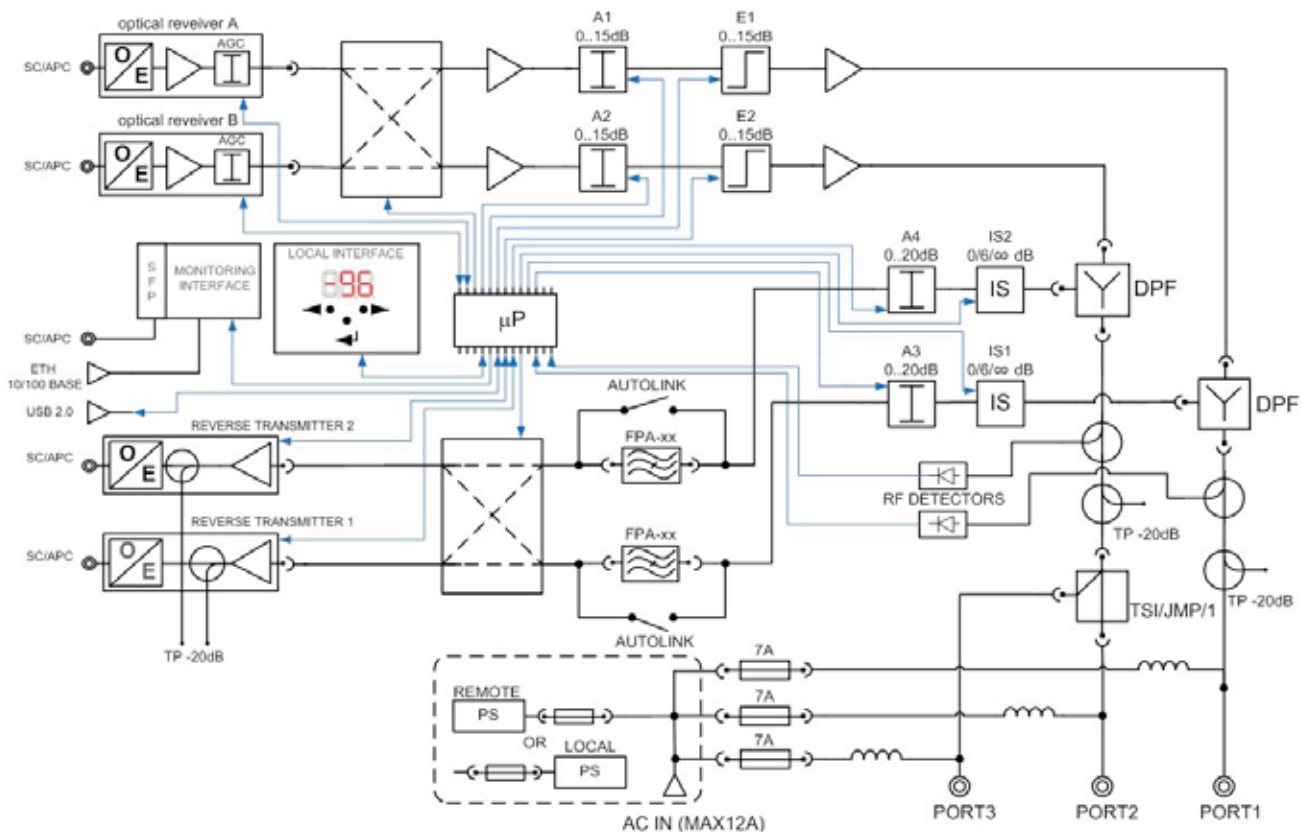

## ORC 2729 - Selection of monitoring parameters via SNMP protocol

Monitoring parameters via SNMP protocol	Read / Write
Hysteresis of the input level ( $P_{in}$ )	Reader / -
Input selection (1/2)	Reader / Writer
RF output level RF ( $P_{out}$ )	Reader / Writer
Alarm output level ( $RF_{min}/RF_{max}$ )	Reader / -
Temperature	Reader / Writer
Alarm temperature ( $T_{min}/T_{max}$ )	Reader / Writer
Level control settings	Reader / Writer
Equalizer settings	Reader / Writer
Location (GPS coordinates)	Reader / Writer
AGC settings	Reader / Writer
Identification (Type, model, serial no., MAC addr.)	Reader / -
Network connection (IP, DHCP)	Reader / Writer
Power Supply	Reader / -
Number of Read / Write legitimate parameters	132

# Fibre Optics

## | Fibre Nodes - Plug-In Modules

### Optical receiver and transmitter module for fibre nodes

- TRX is a receiver module for the local control and monitoring of the forward path, for use in ORC 2729
- OTBMs are return channel modules for use in ORB1923 and ORC 1629
- TTX are return channel transmitter modules for use in ORC 2729



Optical Receiver Modules forward path, for use in ORC 2729/2731 (required min 1 x)	Input	Art. No.
TRX 2729	1	307850

Return path transmitter modules for use in ORB 1923 and 1629 ORC	Wavelength	Unit	Art. No.
OTBM 1310 FP, 0dBm	1310	nm	307810
OTBM 1310 DFB, 3dBm	1310	nm	307811
OTBM 1550 DFB, 3dBm	1550	nm	307812
OTBM 1430nm DFB, CWDM, 3dBm	1430	nm	307823
OTBM 1450nm DFB, CWDM, 3dBm	1450	nm	307824
OTBM 1470nm DFB, CWDM, 3dBm	1470	nm	307825
OTBM 1490nm DFB, CWDM, 3dBm	1490	nm	307826
OTBM 1510nm DFB, CWDM, 3dBm	1510	nm	307827
OTBM 1530nm DFB, CWDM, 3dBm	1530	nm	307828
OTBM 1550nm DFB, CWDM, 3dBm	1550	nm	307829
OTBM 1570nm DFB, CWDM, 3dBm	1570	nm	307830
OTBM 1590nm DFB, CWDM, 3dBm	1590	nm	307831
OTBM 1610nm DFB, CWDM, 3dBm	1610	nm	307832

Return path transmitter modules for use in ORC 2729	Wavelength	Unit	Art. No.
TTX 2729/1310 FP, 0 dBm	1310	nm	307851
TTX 2729/1310 DFB, 3 dBm	1310	nm	307852
TTX 2729/1550 DFB, 3 dBm	1550	nm	307853
TTX 2729/1430nm DFB, CWDM, 3 dBm	1430	nm	307863
TTX 2729/1450nm DFB, CWDM, 3 dBm	1450	nm	307864
TTX 2729/1470nm DFB, CWDM, 3 dBm	1470	nm	307865
TTX 2729/1490nm DFB, CWDM, 3 dBm	1490	nm	307866
TTX 2729/1510nm DFB, CWDM, 3 dBm	1510	nm	307867
TTX 2729/1530nm DFB, CWDM, 3 dBm	1530	nm	307868
TTX 2729/1550nm DFB, CWDM, 3 dBm	1550	nm	307869
TTX 2729/1570nm DFB, CWDM, 3 dBm	1570	nm	307870
TTX 2729/1590nm DFB, CWDM, 3 dBm	1590	nm	307871
TTX 2729/1610nm DFB, CWDM, 3 dBm	1610	nm	307872

# Fibre Optics

## | Fibre Nodes - Plug-In Modules

### Filter-, Splitter and Taps

- DPF is a diplexer for use in ORC 1629 and ORC 2729
- FPA filter modules are used in ORC 1629 and ORC 2729
- TJMP is a bridge module for use in ORC 1629 and ORC 2729
- TSTI is a distributor module for use in ORC 1629 and ORC 2729
- TTSI is a tap module for use in ORC 1629 and ORC 2729

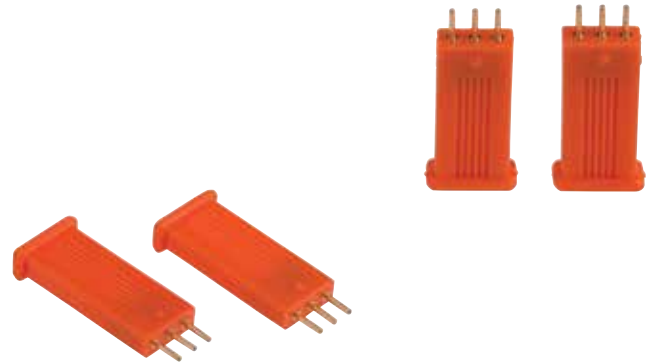

Plug-in modules to configure the RF output (required min 1 x)	RF output 1 Attenuation	RF output 2 Attenuation	Art. No.
TJMP 01, Bridge, Oneway	0 dB	∞	307710
TSTI 01, 2-Way - Splitter modul	-3.5 dB	-3.5 dB	307711
TTSI 26, 2-Way - Tap modul	-2 dB	-6 dB	307712
TTSI 19, 2-Way - Tap modul	-1 dB	-9 dB	307713
TTSI 112, 2-Way - Tap modul	-1 dB	-12 dB	307714
TTSI 114, 2-Way - Tap modul	-1 dB	-14 dB	307715

Diplex module (required min 1 x)	Frequency range	Unit	Art. No.
DPF 2729/30	5...30	MHz	307880
DPF 2729/42	5...42	MHz	307881
DPF 2729/55	5...55	MHz	307882
DPF 2729/65	5...65	MHz	307883

Filtermodule (optional)	Frequency range	Unit	Art. No.
FPA 2729/13	13	MHz	307892
FPA 2729/15	15	MHz	307891
FPA 2729/17	17	MHz	307890



Headquartered in Denmark, Triax is an international supplier of innovative, high-tech solutions for the reception and distribution of video, audio and data signals. The company's products and solutions are used by broadcasters, cable operators, local closed networks and domestic dwelling.

Triax has 9 sales subsidiaries generating a turnover of €100M and operates in more than 60 distributor countries. The Triax team consists of approx. 350 employees and is part of Nielsen & Nielsen Holding, an international group employing 1,600 people.

See [www.com.triax.com](http://www.com.triax.com) for further info.

**[www.com.triax.com](http://www.com.triax.com)**